

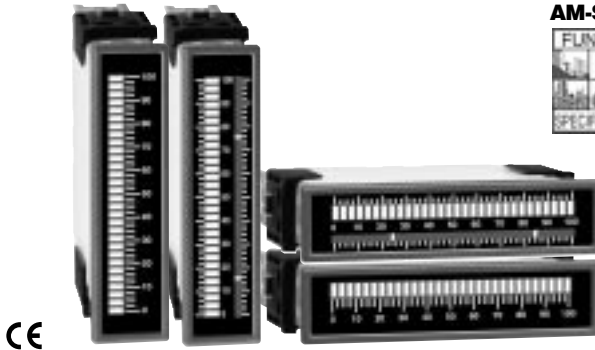

## AM-30, AM-30R1 & AM-30R2

### 31 Segment Bargraph 7 Header Selectable Input Ranges in a 1/16 DIN Case



CE

**5V DC Powered LED Bargraph with Optional Single or Dual Setpoints.**

#### General Features

The AM-30 is a 31-segment 5VDC powered red, green, or amber LED bargraph in a compact DIN case (96x24mm) with a short depth (56.5mm/2.23"). It can be ordered in either a horizontal or vertical format. Single or dual setpoints are available as options. The setpoints are easily adjustable by the user from the front of the meter.

There are seven header selectable input ranges of 50mV, 100mV, 200mV, 1V, 5V, 10V and 4-20mA. The meter comes standard with a scale of 0 – 100%, but any required scale and unit of readout can be specially ordered. The meter may also be ordered with a dot mode display option.

The AM-30 uses a 30-pin PCB edge card connector or optionally a Push-On™ screw terminal connector may be used (see ordering information on page 8). This bargraph is designed especially for use in process applications where a low cost visual analog indication is required.

#### Typical Application Connections

**AM-30/AM-30R1/AM-30R2 with DC Volt Input.**

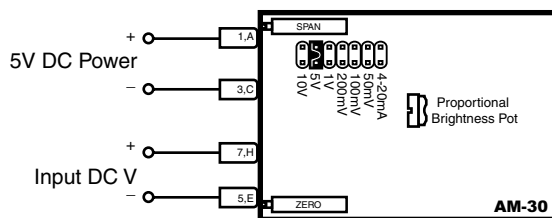

**AM-30/AM-30R1/AM-30R2 with 4 to 20mA Input.**

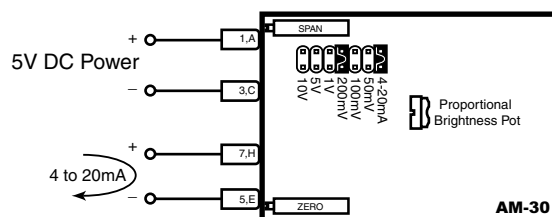

#### Compatibility

The AM-Series have a matching DIN case style that is complementary to the Lynx, Leopard and Tiger family of meters. AM-Meters are the OEM's choice for economical switchboard and process indication. For economy, each model is dedicated to a specific application and designed for quick and easy installation.



#### Specifications

- Input Configuration:** .....Single ended
- Full Scale Ranges:** .....50mV/100mV/200mV/1V/5V/10V/4-20mA
- Input Impedance:** .....> 500kΩ for voltage inputs  
13Ω for 4 to 20mA inputs
- A/D Converter:** .....Flash converter
- Accuracy:** .....1% of full scale
- Temperature Coefficient:**...200ppm/°C (typical)
- Warm Up Time:**.....Instantly reads to specified accuracy
- Conversion Rate:** .....Instantaneous flash conversion
- Display:**.....Thirty-one 0.20" X 0.06" (5.08mm X 1.52mm) bar segments
- Polarity:** .....Operates with positive polarity signals only
- Power Supply:**.....5VDC @ 300mA, 1.5 watt
- Operating Temperature:** ...-10°C to 60°C
- Storage Temperature:**.....-20°C to +70°C
- Relative Humidity:** .....95% (non condensing)
- Case Dimensions:** .....Bezel: 24X96 mm (0.95" X 3.78")  
Depth behind bezel: 56.5 mm (2.23")  
Plus 27 mm (1.06") for Push-on connector  
or plus 17.5 mm (0.69") for Edge connector
- Weight:**.....90.72 gms (3.2 oz)  
136.1 gms (4.8 oz) when packed

### AM-Series, the choice for easy user adjustability

AM-30 . . . . .Red 31 Seg. Bargraph, 0.05/0.1/0.2/1/5/10VDC/4-20mA  
AM-30R1 . . . . .Red 31 Seg. Bargraph, 1 VDC std w/one 2 A/120 VAC relay

AM-30R2 . . . . .Red 31 Seg. Bargraph, 1 VDC std w/two 2 A/120 VAC relays

# Functional Diagram

AM-30 Functional Diagram

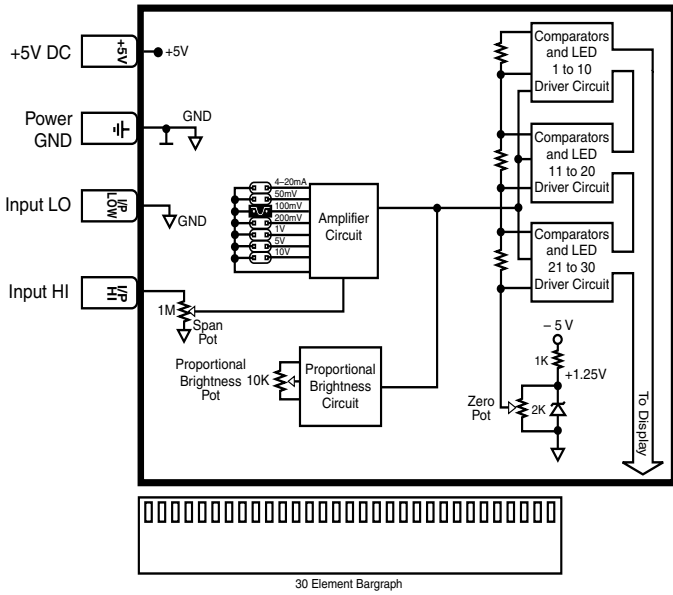

# Connector Pinouts

The Texmate model AM-30 interconnects by means of a standard PC board edge connector having two rows of 15 pins on 0.156" centers. Connectors are available from Texmate or from almost any connector manufacturer.

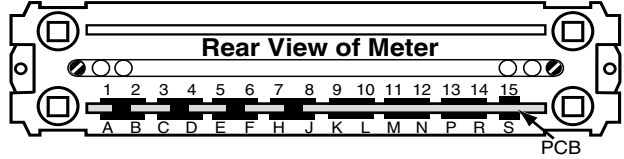

REAR VIEW OF CASE AND CONNECTOR

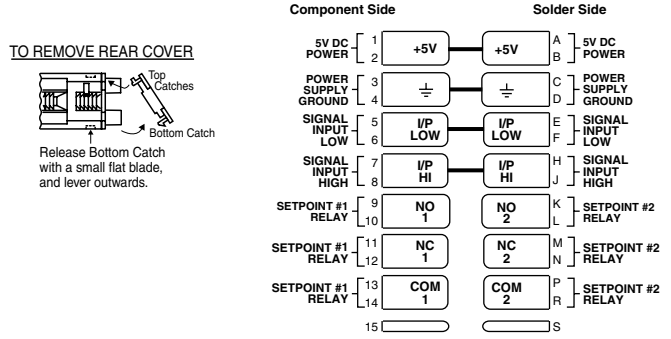

**Pins A, B, 1 and 2** - These pins are internally connected together. The 5VDC @ 300mA is connected here to power the AM-30.

**Pins C, D, 3 and 4** - These pins are internally connected together. They are the Power Supply Ground pins.

**Pins E, F, 5 and 6** - These are the Signal Ground (Input Lo) Pins. They are internally connected to the Power Supply Ground Pins.

**Pins H, J, 7 and 8** - These are the signal input (Input Hi) pins.

**Pins 9 and 10** - Normally open contact of Setpoint #1 relay.

**Pins 11 and 12** - Normally closed contact of Setpoint #1 relay.

**Pins 13 and 14** - Contact Common of Setpoint #1 relay.

**Pins K and L** - Normally open contact of Setpoint #2 relay.

**Pins M and N** - Normally closed contact of Setpoint #2 relay.

**Pins P and R** - Contact Common of Setpoint #2 relay.

**Pins S and 15** - No connection is made to these pins.

# Signal Conditioning Components

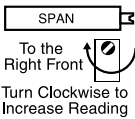

## SPAN Potentiometer (Pot)

The 15 turn SPAN Pot is on the left side (as viewed from the back of the meter). Typical adjustment is 100% of the input signal range.

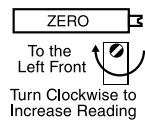

## ZERO Potentiometer (Pot)

The ZERO Pot is to the right side (as viewed from the back of the meter). It enables the Digital Display Span to be offset 50% of the input signal range.

## Proportional Brightness Band Potentiometer

The Proportional Brightness Potentiometer superimposes a proportional brightness band to the leading edge of the bargraph which creates the optical appearance of a pointed arrow. This feature produces a display of infinite resolution. The position of the signal in relation to any two adjacent segments and the scale on the faceplate can be accurately ascertained to within 1%. When the amplitude of the proportional band is adjusted counterclockwise to zero, the smooth proportional advance of the display will be replaced by a step by step movement as each bar is either turned full on or full off.

AM-30 R1 Functional Diagram

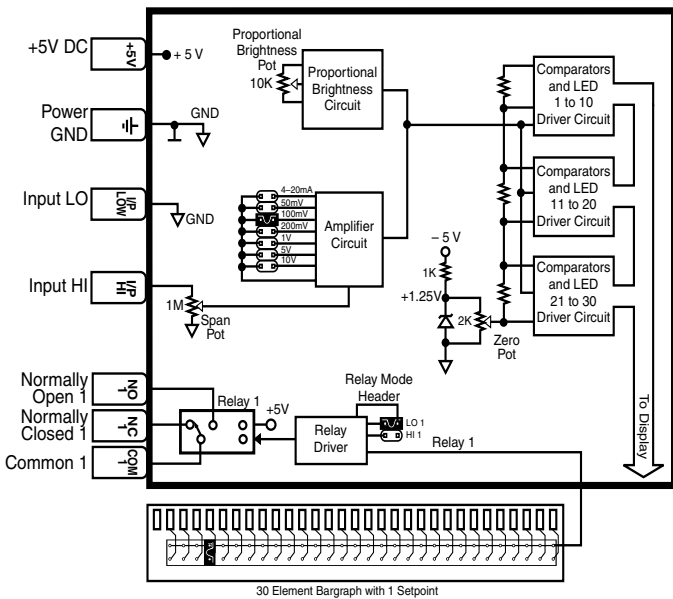

AM-30 R2 Functional Diagram

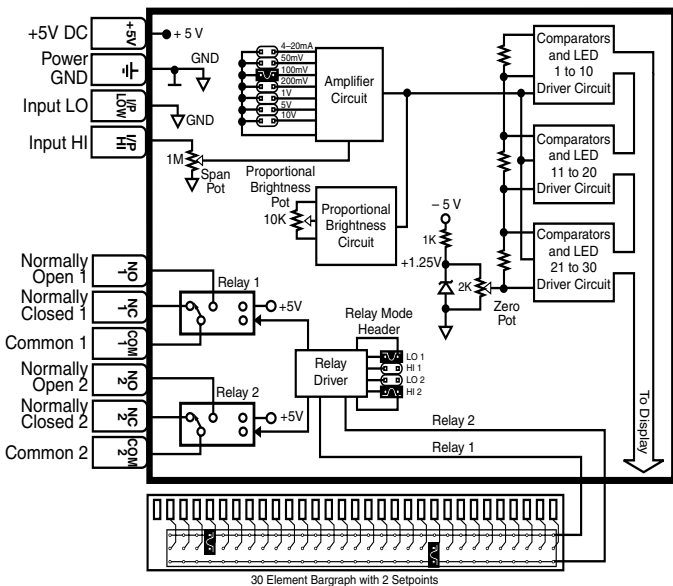

**AM-30**

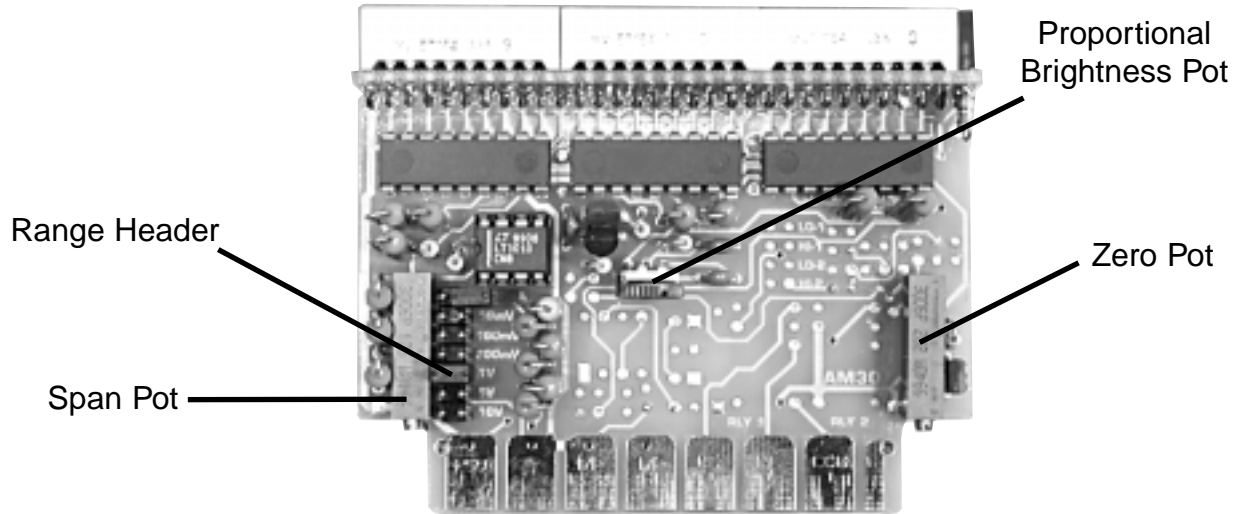

**AM-30 R1**

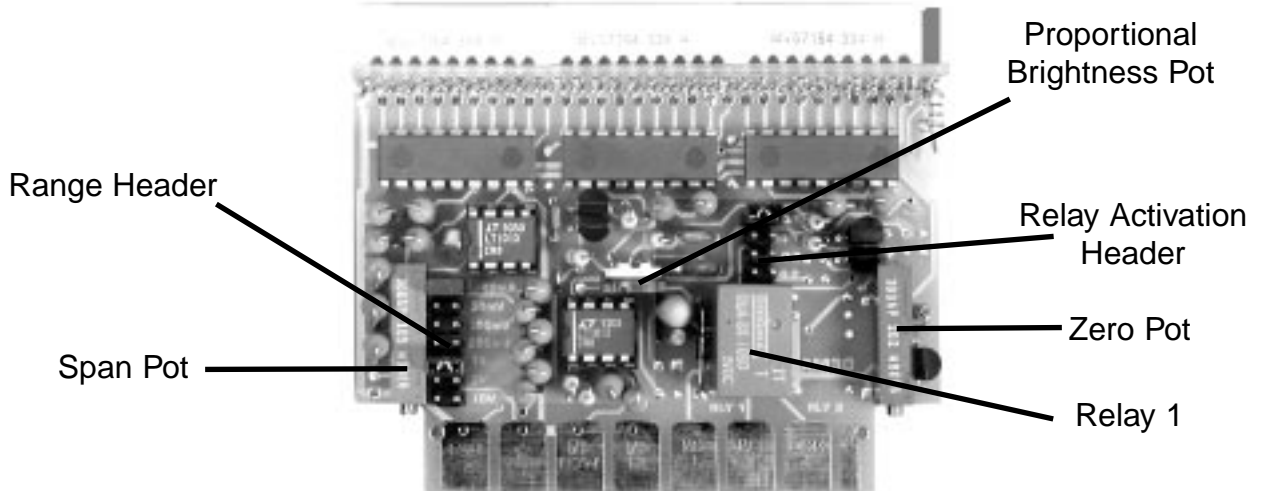

**AM-30 R2**

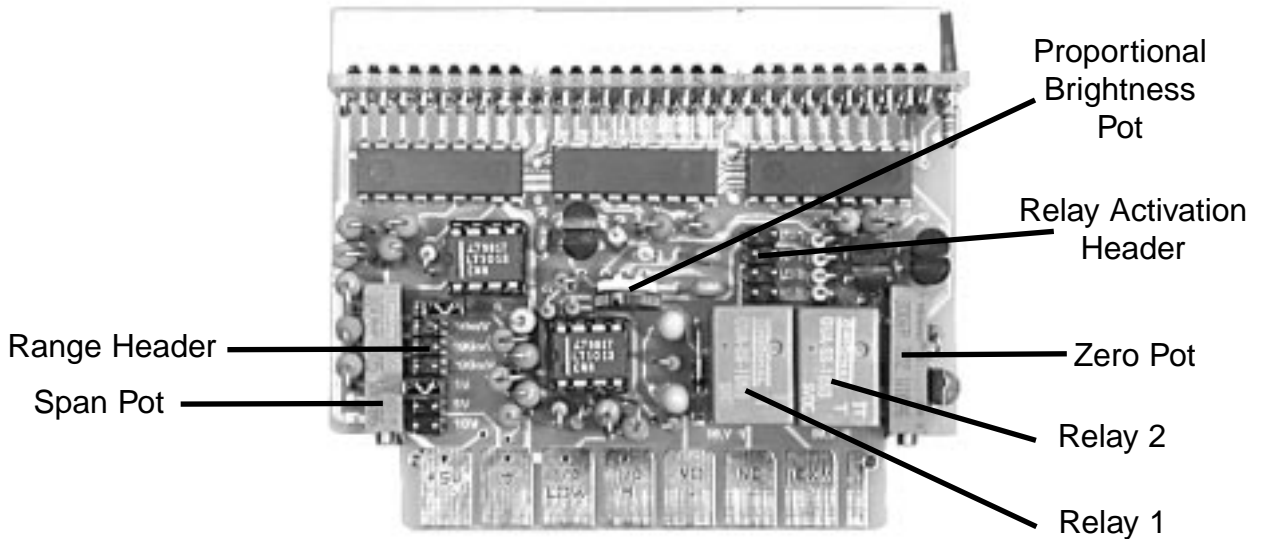

## Selecting the Input Full Scale Range

The AM-30 has seven header selectable ranges. The standard AM-30 is shipped from the factory as a 1V full scale meter. To select any other input range (4 to 20mA, 50mV, 100mV, 200mV, 5V, or 10V), use needlenose pliers to remove the jumper clip and replace it on the appropriate header pins as shown in the diagrams below.

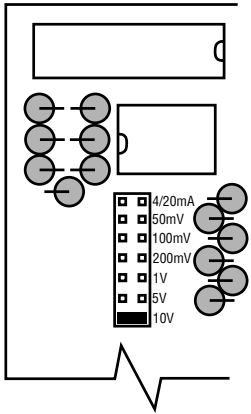

**0 to 10V Input**

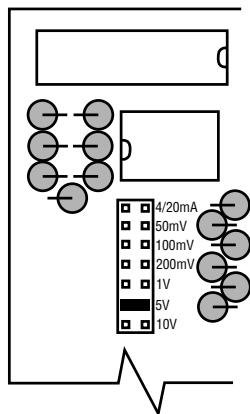

**0 to 5V Input**

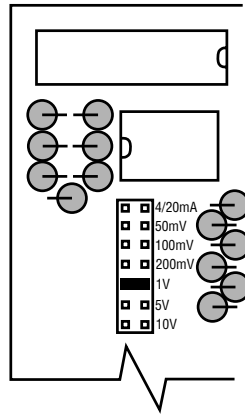

**0 to 1V Input**

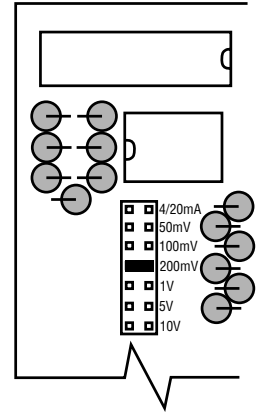

**0 to 200mV Input**

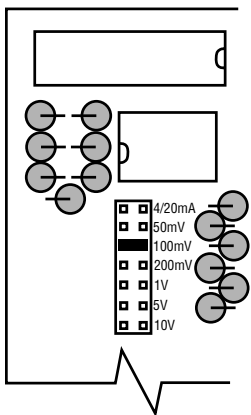

**0 to 100mV Input**

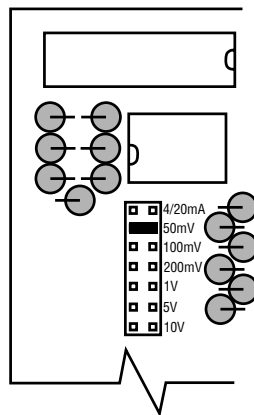

**0 to 50mV Input**

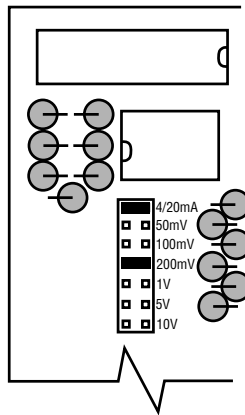

**4 to 20mA Input**

For 4 to 20mA inputs, jumper clips must be put in both the 4 to 20mA and 200mV positions. A second jumper clip is provided for this purpose.

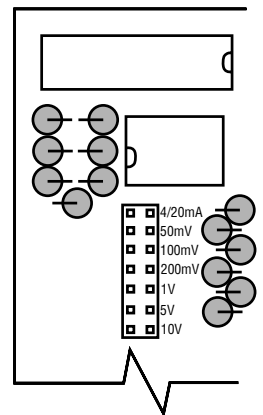

If there is no jumper clip inserted on the input header pin when the power is turned on, the AM-30 goes into the display test mode and all segments of the display come on.

## Selecting the Relay Activation Modes

There are four activation modes available for the AM-30R2 with relay options. To change the activation mode, use needlenose pliers to remove and replace the shorting clips on the relay activation header, as shown below.

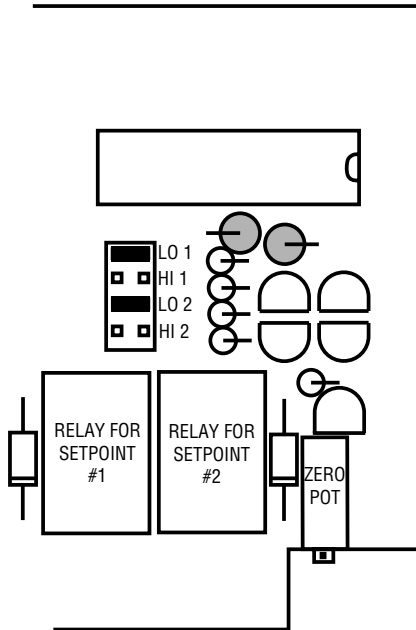

Setpoint #1 will activate whenever the input is LESS THAN setpoint #1.  
Setpoint #2 will activate whenever the input is LESS THAN setpoint #2.

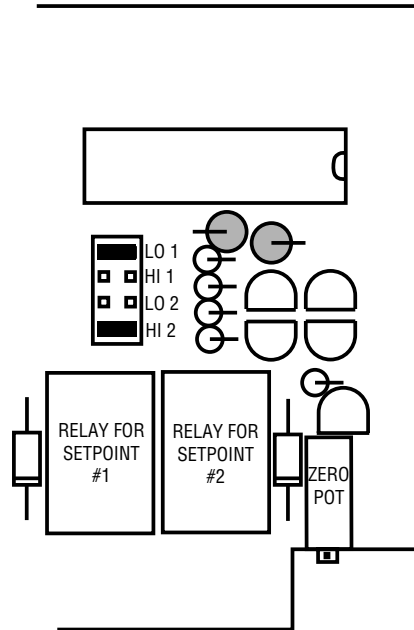

Setpoint #1 will activate whenever the input is LESS THAN setpoint #1.  
Setpoint #2 will activate whenever the input is GREATER THAN setpoint #2.  
The standard AM-30 with dual relay option is shipped from the factory, with this setting.

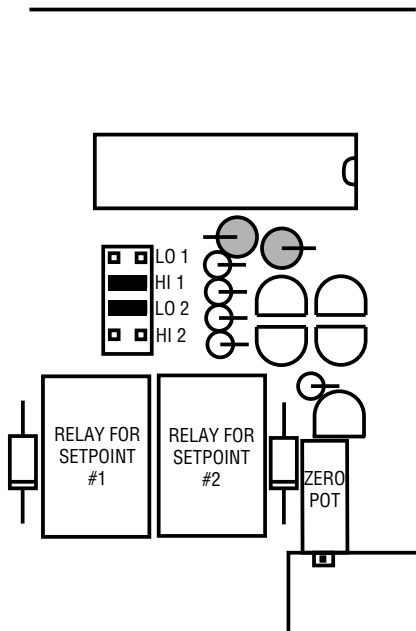

Setpoint #1 will activate whenever the input is GREATER THAN setpoint #1.  
Setpoint #2 will activate whenever the input is LESS THAN setpoint #2.

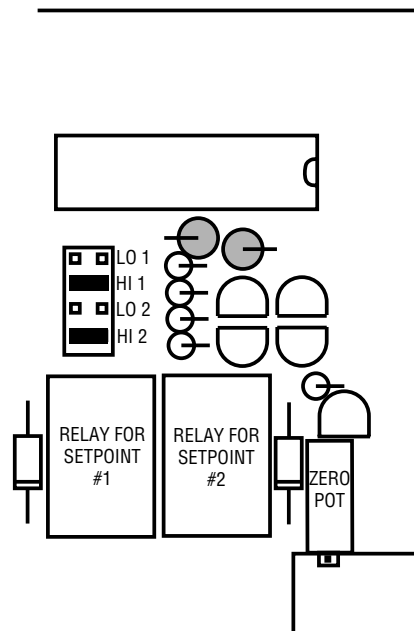

Setpoint #1 will activate whenever the input is GREATER THAN setpoint #1.  
Setpoint #2 will activate whenever the input is GREATER THAN setpoint #2.

## Calibration Procedure

1. Select the required input range. (See "Selecting the Input Full Scale Range" above for details).
2. Input the minimum signal to the AM-30. Adjust the ZERO pot so that only one segment stays on.
3. Input the maximum signal to the AM-30. Adjust the SPAN pot so that all the segments just light up.
4. In the case of the AM-30R1 and AM-30R2, select the relay activation mode (details on page 6) and setpoints (details on page 2).
5. The meter is now calibrated and ready for use.

## CHANGING THE SETPOINTS FROM THE FRONT OF THE METER

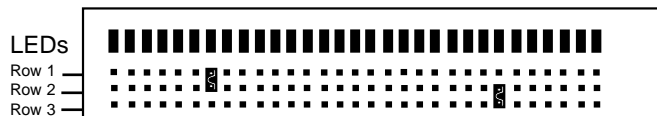

### FRONT OF METER WITH BEZEL AND FILTER REMOVED

In the case of the AM-30R1 and AM-30R2, which have relays, remove the front bezel and faceplates. Use needlenose pliers to remove and reposition the setpoint jumper clips.

**For Setpoint #1:** Insert the jumper clip between Row #1 and Row #2, directly below the LED that you wish to activate.

**For Setpoint #2:** Insert the jumper clip between Row #2 and Row #3, directly below the LED that you wish to activate.

**AM-30 WITH DOT MODE OPTION:** The AM-30 may be ordered with the dot mode option. Please note that NO SET POINTS are available in this mode. For a 4-20mA input (or virtually any positive input), the dot mode AM-30 is easily user scaled to be a center zero meter.

## Power Supply

The AM-30, AM-30R1 & AM-30R2 ship from the factory with an isolated 5VDC power supply.

## Push-On Screw Terminals

They provide the greatest convenience and ease of use

Texmate's exclusive optional Push-On Connectors combine an edge card connector and a 10 position screw terminal block. Push-On Connectors are ordered preconfigured for each specific power supply voltage and each optional power supply available for the AM-Series.



CN-PUSH/AM  
CN-PUSH/AMR

CN-PUSH/A24  
CN-PUSH/AR24

## Optional PCB Edge Connector

### PCB Edge Connector

A standard 30-pin edge connector (two rows of 15 pins on 0.156" centers) may be used to connect the AM-30, AM-30R1 & AM-30R2 meters. Order part no. CN-L15.



## Custom Face Plates and Scales



Texmate Produces Thousands of Custom OEM Face Plates

Have Texmate Design and Build a Custom Face Plate to Suit your Next project!

- Custom face plates have a non-recurring artwork charge. A serial number is then assigned to each artwork, to facilitate re-ordering. We prefer custom logos and special artwork to be supplied in an Illustrator or Photoshop file format.
- The non-recurring artwork charge is less if you choose elements from our library. The standard scales and numbers in the library are shown below. The standard library captions are shown on the caption sheet. (page 18)
- Small Run or One-Off custom face plates incur an installation charge, and are generally printed on a special plastic film, which is then laminated to custom faceplate blanks as required.

- Large Run (250 pieces min): custom face plates are production silk screened, issued a part number, and held in stock for free installation as required by customer orders.
- OEMs may also order Custom Meter Labels, Box Labels Custom Data Sheets and Instruction Manuals.

Part Number	Description	List
<b>Small Run Custom Face plates for Bargraphs</b>		
ART-FB-S/L	.NRC for artwork & set-up Faceplate/Library	\$.35
ART-FB-S/N	.NRC for artwork & set-up Faceplate/Non-Library	\$.55
ART-FB-S/L/C	.NRC for artwork & set-up Faceplate/Library/Co.Logo	\$.75
ART-FB-S/N/C	.NRC for artwork & set-up Faceplate/Non-Library/Co.Logo	\$.95
ART-FB-001	.Install Faceplate per meter - 1 color	\$.10
ART-FB-002	.Install Faceplate per meter - 2 color	\$.20
ART-FB-003	.Install Faceplate per meter - 3 color	\$.30
Specify artwork serial number when ordering face plate installation. ie: AFB-XXXXX		

### Large Run Custom Face plates for Bargraphs

ART-FL-001	.Minimum order \$250 (\$250x\$1) - 1 color	\$.10
ART-FL-002	.Minimum order \$350 (\$250x\$1.40) - 2 color	\$.20
ART-FL-003	.Minimum order \$450 (\$250x\$1.80) - 3 color	\$.30
When ordering Large Run Face plates to be installed specify the custom part number issued for each different artwork. ie: 77-FLXXXX		

# Standard Face Plates and Scales

- Unless otherwise specified, a standard 0-100 scaled face plate with white letters on a black background is provided with each meter. In those cases where a temperature modules is ordered, a 0-300 °F (white on black) face plate will be provided as standard.
- Alternatively a face plate with black letters on a white background or a blank, white or black face plate, may be ordered as a no charge substitute. For temperature applications there are also several different optional face plates that may be ordered as a no charge substitute. (See below). Customized face plates with special scaling can also be ordered.

Optional no charge substitute faceplates for Temperature may be ordered scaled 0 to 300°F or 0 to 150°C, Vertical or Horizontal in Black or White background

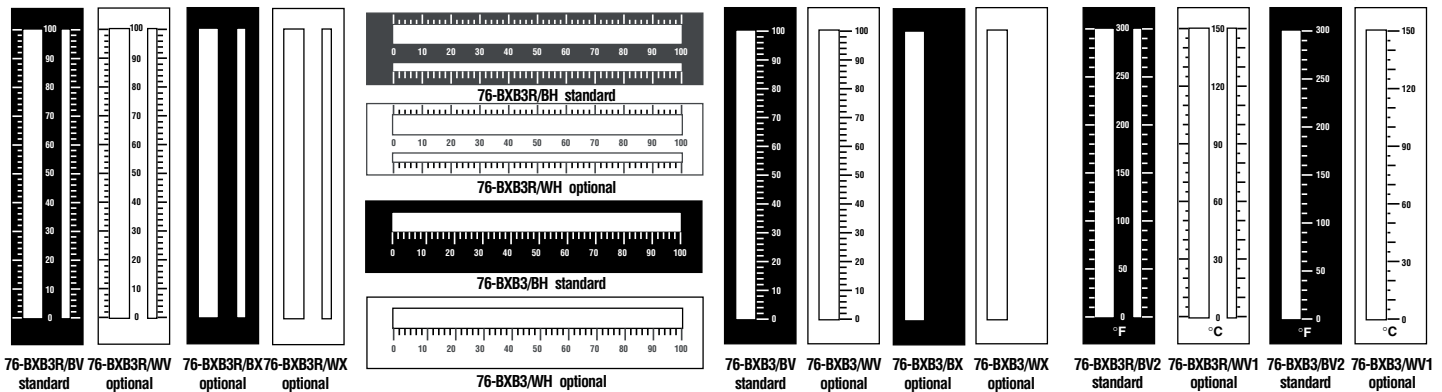

## Face plate scales and numbers are shown close to actual size

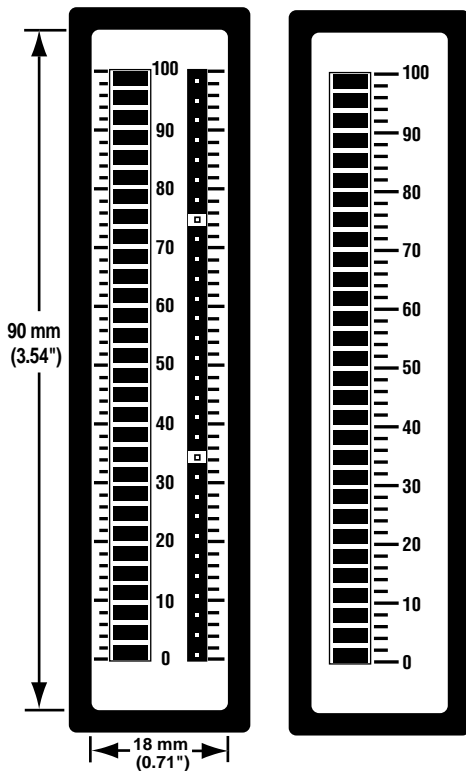

1	1.2	1.5	2	2.5	3	4	4.5	5	6	7.5	8	9
10	12	15	20	25	30	40	45	50	60	75	80	90
100	120	150	200	250	300	400	450	500	600	750	800	900
1000	1200	1500	2000	2500	3000	4000	4500	5000	6000	7500	8000	9000
100	12	15	20	25	30	40	45	50	60	75	80	90
90												
80	10											
70		12										
60	8		15									
50		6		20								
40	6											
30	4		10									
20		3		15								
10	2		5									
0	0	0	0	0	0	0	0	0	0	0	0	0
10x5	6x2x2	5x3x2	4x5x2	5x5x2	6x5	8x5	9x5	10x5	6x5	7.5x5	8x5	9x5
Div. 50	24	15	20	25	30	40	45	50	30	37.5	40	45

## Standard Caption Sheets (white or black lettering for do-it-yourself customizing)

Clear self-adhesive caption sheets with white or black lettering are provided for each meter shipped with a standard or optional faceplate.

AHEAD	AC Vars	AC Amperes	AC Kilowatts	AIR PRESSURE	AC Milliampers
ALARM	AC Volts	AC Kilovars	AC Millivolts	AC Kiloamperes	Battery Voltage
BOILER	AC Watts	AC Kilovolts	BPH X 1000	AC Megavars	Backup Voltage
Cycles	BEARING	AIR FLOW	CFH X 1000	AC Megawatts	Displacement
Depth	COOLANT	BBLs/HOUR	DC Amperes	AC Watts/Vars	DC Amps to Ground
HEATER	DC Volts	BFM AMPS	DC Kilowatts	CENTIMETERS	DC Microamperes
Height	DC Watts	BHP X 100	DC Kilovolts	DC Kilampers	DC Milliampers
Hertz	Degrees	BLOWER	DC Millivolts	FD FAN AMPS	GALLONS / MINUTE
Hours	ENGINE	DC Current	FPM X 100	IN. H <sub>2</sub> O PRESS	GENERATOR AMPS
INCHES	EXHAUST	Dew Point	FPM X 1000	LBS/MINUTE	LBS PER GALLON
Input	Humidity	Degrees C	GPM X 1000	LEVEL INCHES	LOAD LIMIT PERCENT
PORT	METERS	Degrees F	HORSEPOWER	LEVEL GALLONS	MANIFOLD PRESSURE
PUMP	Output	Degrees K	INCHES WC	LEVEL PERCENT	MILL LOAD AMPS
Preset	Percent	Degrees R	INCHES H <sub>2</sub> O	MILLIMETERS	MOTOR LOAD AMPS
Reset	Program	FPM X 10	KILOWATTS	Percent Current	Percent Horsepower
SHAFT	Pounds	Frequency	LBS X 1000	Percent Load	OXYGEN PERCENT
SPEED	Pulses	FUEL FLOW	MEGAWATTS	PERCENT OPEN	TEMPERATURE °C
Setup	RUDDER	GALLONS	Power Factor	RATE of TURN	TEMPERATURE °F
TABLE	SPINDLE	IN. WATER	Phase Angle	STEAM TEMP °F	Motor Load Percent
Total	SQ ROOT	LEVEL FT.	RPM X 100	TONS / HOUR	LEFT RIGHT
VALVE	Set Point	LBS X 100	STARBOARD	OIL PRESSURE	FRONT REAR
Valley	THRUST	POSITION	TANK LEVEL	WATER LEVEL	FORWARD REVERSE
WATTS	TURBINE	TONS X 10	VAC MM HG	1000 LBS/HOUR	TOP BOTTOM (L498)

A	AC	E <sub>g</sub>	Btu	bars	CFH	BHP	Low	inch/	CosØ	AMPS	BBL/HR
J	Ah	kJ	bar	cal <sub>15</sub>	CFM	IPS	High	Kcal	FEET	GALS	BBL/MIN
K	cd	kV	cal	cm <sup>-1</sup>	CFS	IPH	MGD	kg/hr	Hold	INHG	DEG/MIN
l	dB	kW	cm	cm <sup>2</sup>	COS	Kg/h	Mld	kVAR	Km <sup>3</sup> /h	m/min	FT H <sub>2</sub> O
m	DC	ml	FT <sup>3</sup>	cm <sup>3</sup>	CPH	KPH	MPH	KW/s	MWH	m/sec	IN. H <sub>2</sub> O
V	FT	NL	lbs	dm <sup>3</sup>	CPM	KPM	MPS	RPM/s	MWs	Nm <sup>3</sup> /h	Kg/cm <sup>2</sup>
α	HP	Pa	IN <sup>2</sup>	H <sub>2</sub> O	CPS	KPS	N/m <sup>2</sup>	MPM	mbar	Ohms	KNOTS
β	Hz	PF	kg/	kPa	DCA	KWH	ORP	M <sup>3</sup> /hr	ml/m <sup>3</sup>	PSIA	kg/sec
φ	Kg	pH	mA	l/s	FPH	lb/ft	PPH	Upm	mm/s	PSIG	Mvars
Ω	kA	sin	mS	l/h	FPM	lb/in	PPM	VAC	Peak	PSIG	Nm <sup>3</sup> /H <sub>2</sub> O
Δ	L <sup>3</sup>	t/h	mV	l/m	FPS	LPH	PPS	Vars	PORT	PSIR	mmHg
μ	m <sup>3</sup>	yd <sup>3</sup>	Nm	lb/h	GAL	LPM	RPH	VDC	STRB	SCFM	VOLTS
∅	W	μA	oz	MW	GMP	LPS	RPS	w/m <sup>2</sup>	TARE	TORR	%LOAD
γ	°C	μS	RH	min	GPH	m <sup>3</sup> /h	phi	YPM	TONS	U/min	%OPEN
%	°F	μV	1/h	mm	GPM	m <sup>3</sup> /m	psi	YPS	X100	x10kN	→
∠	°K	μΩ	μm	Sm <sup>3</sup>	GPS	m <sup>3</sup> /S	X10	μPa	%KW	X1000	←

# Case Dimensions and Panel Cutouts

### PANEL CUTOUT

Case will mount in standard 1/16 DIN cutouts

Panel adaptor plates are available to retrofit most existing panel cutouts.

For additional strength, extra Mounting Slide Clips can be ordered and doubled up one behind the other.  
P/N:(75-DMT96X24)

When extra panel mounting tightness is required, optional Screw Mounting Clips are included which fit on the Mounting Slide Clips.

### FRONT VIEW

1/16 DIN (96x24mm)

Various bezel colors are available. Black is standard.

### SIDE VIEW

Push-On Connector P/N:(CN/PUSH/BN)

### TO REMOVE REAR COVER

Release Bottom Catch with a small flat blade, and lever outwards.

### TOP VIEW

92.8 mm (3.6") Widest mountable panel cutout without using adaptors.

97.8 mm (3.86")

91 mm (3.59")

25.4 mm (3.78") Max. panel thickness

The 96x24mm case is particularly suitable for mounting in mosaic panels or insulative panels. They can also stack mount, 2 up in existing cut-outs for 1/8 DIN (96x48mm) or 4 up in 1/4 DIN (96x96mm).

## Ordering Information

### Standard Options for this Model Number

Part Number .Description .List

#### ► BASIC MODEL NUMBER

AM-30 . . . . .Red 31 Seg. Bargraph, 0.05/0.1/0.2/1/5/10VDC/4-20mA . . . \$109  
 AM-30R1 . . . . .Red 31 Seg. Bargraph, 1 VDC std w/one 2 A/120 VAC relay . . \$139  
 AM-30R2 . . . . .Red 31 Seg. Bargraph, 1 VDC std w/two 2 A/120 VAC relay . . \$169

#### ► DISPLAY

STANDARD . . Vertical Red . . . . .N/C  
 AM-HORZ/RED . .Horizontal Red LED option . . . . . \$10  
 AM-VERT/GRN . .Vertical Green LED option . . . . . \$10  
 AM-HORZ/GRN . .Horizontal Green LED option . . . . . \$10  
 AM-MULTI . . .Red, green or amber LEDs (10 seg. increments) . . . \$10  
 AM-30DOT . . .Dot mode - one segment display (AM-30 only) . . . \$10  
 AM-30DOT/CZ . .Center zero dot mode (AM-30 only) . . . \$10

#### ► POWER SUPPLY

STANDARD . . 5 V DC . . . . .N/C  
 V0-24VDC . . . . .Non-isolated 24 V DC . . . . . \$30

### Special Options and Accessories

Part Number .Description .List

#### ► SPECIAL OPTIONS (Specify Inputs & Req. Reading)

HD-CHANGE . . . . .Factory Range Change from bolded ranges listed (AM-30) . . . \$7  
 CB-FS35 . . . . .Non-Std Range (AM-30) . . . . . \$12  
 AM-30RELAYH . .Factory Installed 200mA/250VAC relay (AM-30R1 & R2) . . . \$5

#### ► ACCESSORIES

CN-L15 . . . . .PCB Edge Connector, Solder Type, Dual row 15 Pins (AM-30) . . . \$3.75  
 CN-PUSH/AM . . .AM-30 / 5VDC power Push-on Screw Terminal Block Connector . . \$18  
 CN-PUSH/AMR . . .AM-30R1 & R2 / 5VDC Push-on Screw Terminal Block Conn. . . \$18  
 CN-PUSH/A24 . . .AM-30 / 24VDC Push-on Screw Terminal Block Connector . . . \$18  
 CN-PUSH/AR24 . . .AM030R1 & R2 / 24VDC Push-on Screw Terminal block Conn. . . \$18  
 75-DMTC96X24 . .Side Slide Brackets, extra set (96x24mm only) . . . . . \$2  
 75-DBBZ96X24 . .Black Bezel for 96x24mm Case, BN and AM series . . . . . \$2  
 DN.CAS96X24 . . .Din Case 96 X 24 Short Depth Plus Accessories . . . . . \$20  
 OP-MTLCLIP . . . . .Screw Mounting Clips (2 pc) to screw tighten slide brackets . . . . \$6  
 75-DTP96X24 . . .Black Metal Trim Plate (96x24mm Case) 1 Meter . . . . . \$6  
 75-DTP2X9624 . . .Black Metal Trim Plate (96x24mm Case) 2 Meters . . . . . \$6  
 75-DTP3X9624 . . .Black Metal Trim Plate (96x24mm Case) 3 Meters . . . . . \$6

Prices subject to change without notice.

### WARRANTY

Texmate warrants that its products are free from defects in material and workmanship under normal use and service for a period of one year from date of shipment. Texmate's obligations under this warranty are limited to replacement or repair, at its option, at its factory, of any of the products which shall, within the applicable period after shipment, be returned to Texmate's facility, transportation charges pre-paid, and which are, after examination, disclosed to the satisfaction of Texmate to be thus defective. The warranty shall not apply to any equipment which shall have been repaired or altered, except by Texmate, or which shall have been subjected to misuse, negligence, or accident. In no case shall Texmate's liability exceed the original purchase price. The aforementioned provisions do not extend the original warranty period of any product which has been either repaired or replaced by Texmate.

### USER'S RESPONSIBILITY

We are pleased to offer suggestions on the use of our various products either by way of printed matter or through direct contact with our sales/application engineering staff. However, since we have no control over the use of our products once they are shipped, NO WARRANTY WHETHER OF MERCHANTABILITY, FITNESS FOR PURPOSE, OR OTHERWISE is made beyond the repair, replacement, or refund of purchase price at the sole discretion of Texmate. Users shall determine the suitability of the product for the intended application before using, and the users assume all risk and liability whatsoever in connection therewith, regardless of any of our suggestions or statements as to application or construction. In no event shall Texmate's liability, in law or otherwise, be in excess of the purchase price of the product.

Texmate cannot assume responsibility for any circuitry described. No circuit patent or software licenses are implied. Texmate reserves the right to change circuitry, operating software, specifications, and prices without notice at any time.



995 Park Center Drive • Vista, CA 92081-8397  
 Tel: 1-760-598-9899 • USA 1-800-839-6283 • That's 1-800-TEXMATE  
 Fax: 1-760-598-9828 • Email: sales@texmate.com • Web: www.texmate.com  
 Texmate has facilities in Japan, New Zealand, Taiwan, and Thailand. We also have authorized distributors throughout the USA and in 28 other countries.

For product details visit [www.texmate.com](http://www.texmate.com)

Local Distributor Address